

**Sabit bağlantı elemanı**  
Holding connection part  
قطعة التثبيت الثابتة

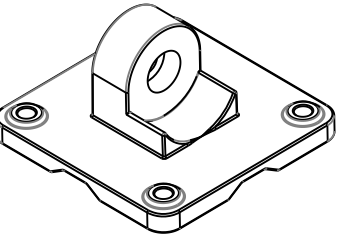

2 Adet

**Hareketli bağlantı elemanı**  
Moving connection part  
قطعة التثبيت المتحركة

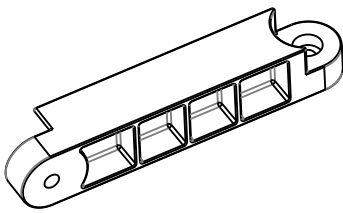

1 Adet

**Boru bağlantı elemanı**  
Pipe connection part  
قطعة التثبيت للعمود

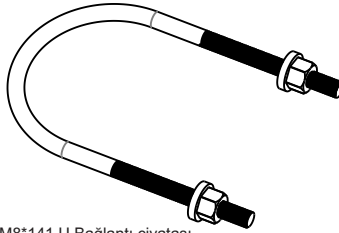

M8\*141 U Bağlantı civatası  
M8 Flaşlı Somun 2 Takım

**Duvar bağlantı elemanı**  
Wall placement part  
قطعة التثبيت للحائط

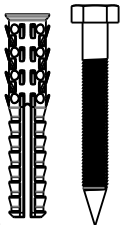

M8\*80 Trifon vida  
Ø12 Plastik Dubel 4 Takım

**Montaj civatası**  
Montage bolt  
براغي التثبيت

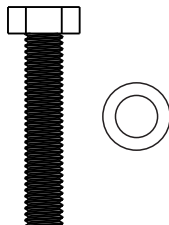

M8\*40 Civata  
M8 Pul 4 Takım

**Montaj civatası**  
Montage bolt  
براغي التثبيت

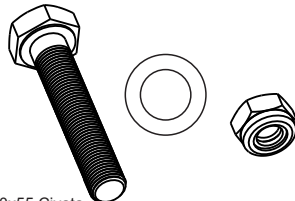

M10x55 Civata  
M10 Fiberli Somun  
M10 Pul 2 Takım

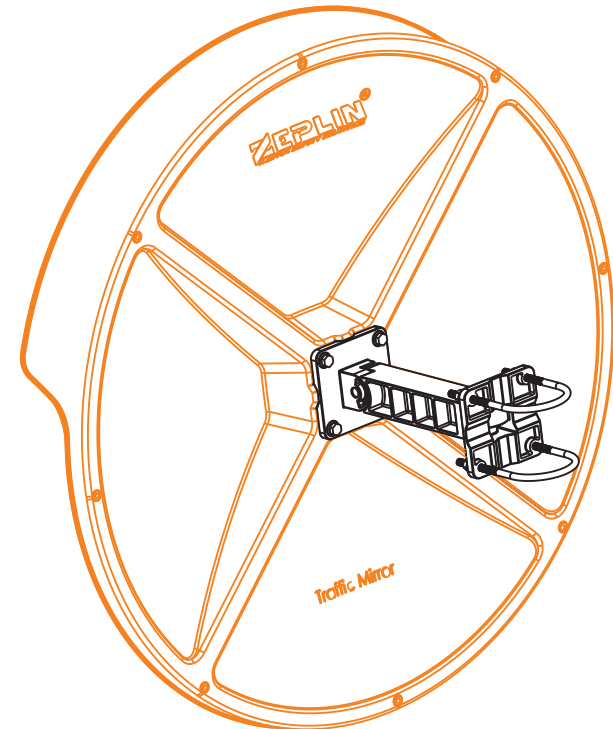

### Dikkat

- 1- Resim üzerinden ölçü aleti ile ölçü almayın.
- 2- Formu veya ölçüsü değişen resimleri teknik büroya bildirin.
- 3- Resim üzerinde kontrol edenden başkası değişiklik yapamaz.

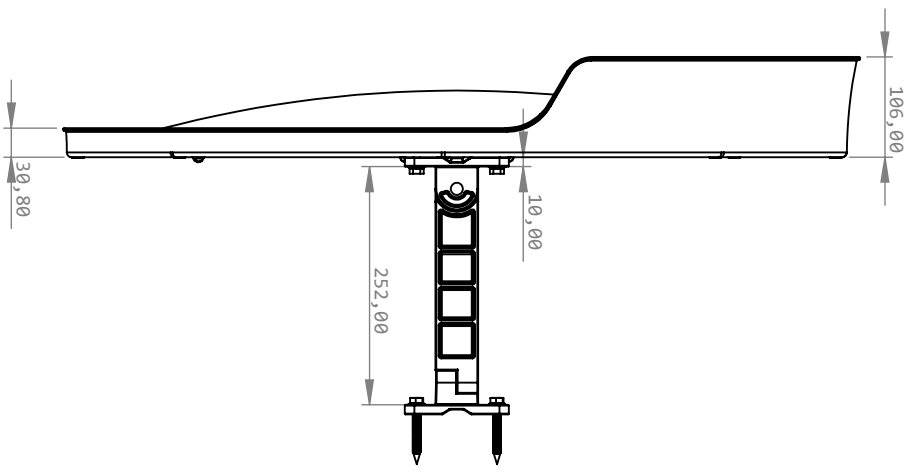
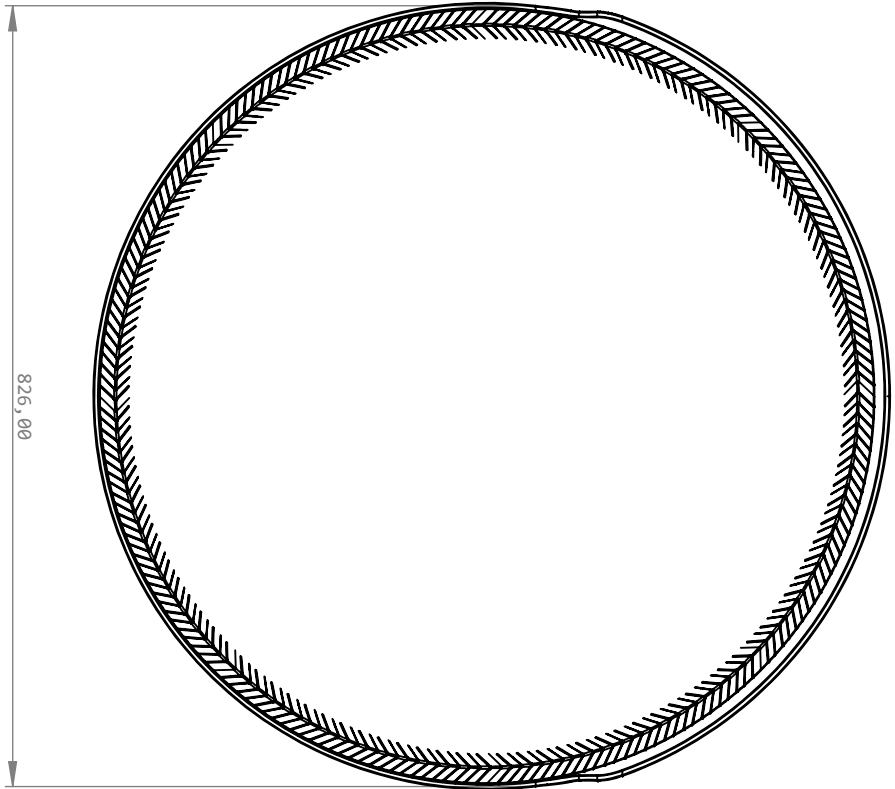

### CONVEX MIRROR

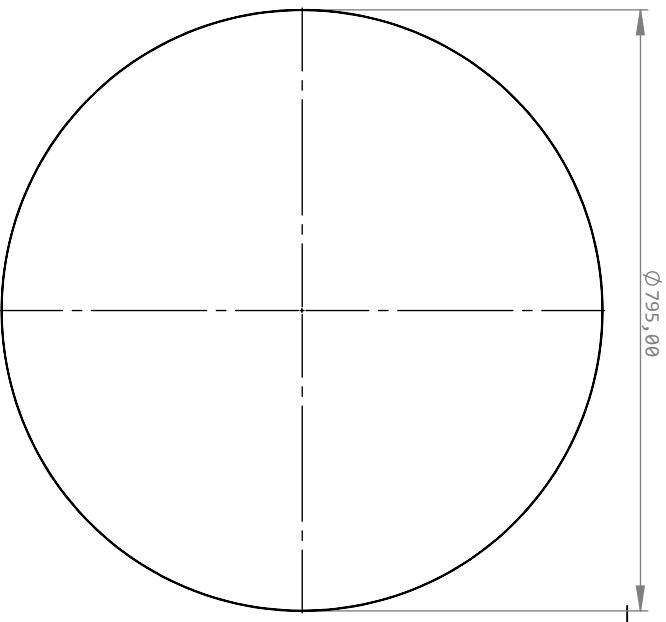
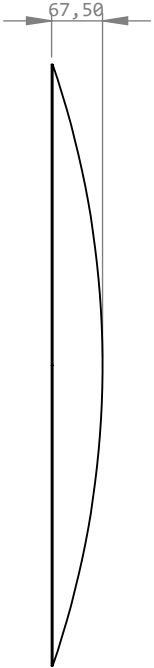

ÇİZEN DRAWN BY	ADI - SOYADI NAME - SURNAME	TARİH DATE	İMZA SIGN	MALZEME MATERIAL	AĞIRLIK (KG) MASS (KG)	REVİZYON NO REVISION NO	SAYFA NO PAGE NR
KONTROL CONTROL	---	---	---	STOK KODU STOCK CODE	---	---	1/1
ONAY APPROVAL	---	---	---	---	---	---	---
ÖLÇEK SCALE	1:5	---	---	---	---	---	---
PARÇAMONTAJ ADI PART/ASSEMBLY NAME	---	---	---	TEKNİK RESİM AÇIKLAMASI DRAWING DESCRIPTION	---	---	---
---	---	---	---	---	---	---	---